

YUEQING HONGYI ELECTRONICS CO., LTD
乐清市宏一电子有限公司

SPECIFICATION FOR APPROVAL

承认书

CUSTOMER 客户名称	
DESCRIPRION 产品名称	SPH 系列连接器
ITEM NO 编 号	HY-A20018 (A52)
DATE 日 期	2022-09-11

CUSTOMER ACKNOWLEDGEMENT SEAL

客户承认印签

(APPROVAL) 核准	(ENGINEERING) 工程	(PURCHASE) 采购	(QUALITY) 品质
承认结果: <input type="checkbox"/> 通过 <input type="checkbox"/> 不通过 <input type="checkbox"/> 重新送样			

IS09001

IS014001

IS045001

IATF16949 体系认证

ADD: No. 30, Wenjing Road, Houyu village, Shifan street, Yueqing City, Zhejiang Province

地址: 浙江省乐清市石帆街道后屿文景路 30 号

TEL:0577-62380521

FAX: 0577-62381979 P.C:325608

http: //www.zhehongyi.com

E-MAIL:yaohongxiao88@126.com

产 品 承 认 书 目 录

1、封面	1-1
2、修订履历	2-2
2、目录	3-3
3、技术规范	4-9
4、产品图纸	10-15

PRODUCT SPECIFICATION

产品规范

1、Scope

适用范围

This specification includes the following specifications, including the specification of SPH series connector

本规范包括下列此种规格包括 SPH 系列连接器规格说明

2、Appearance and Dimension

外观及尺寸

2.1 Appearance:Product surface without defect、dirt、crack、and mechanical damang, Contactwithout rust, plating not oxidized and not peeled.

产品表面不应有对制品有害的缺陷、污垢、裂痕及机械损伤；接触件无锈蚀、镀层氧化脱落等现象

2.2 Dimension:According to drawings

外形尺寸：依照附图

3、Disposal of Material and surface

材料与表面处理

Specification 规格内容	Material 材质	Finish 表面处理	Environmental protection grade 环保等级	
Terminal 端子	Phosphor bronze 磷铜 厚 0.20mm	Tin Plating:2.5-5 μ m 镀锡：2.5-5 μ m	RoHS2.0	
Housing 胶壳	PA66 UL94V-0	Color: White 颜色：白色		
Wafer 直/弯 针座	Plastic 塑壳	PA66 UL94V-0		Color:Beige 颜色：米色
	Contact 插针	Brass 黄铜 厚 0.50mm		Tin Plating:2.5~5 μ m 镀锡：2.5~5 μ m

4、Ratings and applicable wires

额定等级

Item 项目	Standard 规格
Rated Voltage 额定电压	250V AC/DC
Rated Current 额定电流	3A AC/DC
Ambient temperature Range 使用温度范围	-25°C- +85°C
Applicable wire insulation 适用线径	AWG24#-30#

5、Electrical Performance

电气性能

N0. 序号	Ltem 项目	Test mode 试验方法	Requirement 技术要求
5.1	ContactResistance 接触电阻	Male female cooperation, open voltage less than 20mV, current 100mA detection connector at both ends 公母配合, 开放电压20mV 以下, 电流100mA 检测连接器连接器两端	Initial:20mΩ Max 初始: 20mΩ Max After Test: 30mΩ Max 试验后: 30mΩ Max
5.2	withstandvoltage 耐电压	Mate connectors, apply 800V AC for 1 minute between adjacent terminal or ground 公母配合, 在相邻端子, 端子与地片之间, 使用800V 的交流电1 分钟, 检测连接器	No Breakdown and Flashover 外观无损伤, 无打火花
5.3	InsulationResistance 绝缘电阻	Mate connectors, apply 500V DC between adjacent terminal or ground 公母配合, 在相邻端子, 端子与地片之间, 使用500V 的直流电, 检测连接器	1000MΩ Min

6、机械性能

Mechanical Performance

NO. 序号	Ltem 项目	Test mode 试验方法		Requirement 技术要求
6.1	Terminal crimping wire strength 端子压接导线强度	Fix the crimped terminal, apply axial pull out force on thewire 固定铆线后的端子, 使电线与端 子分离时所需的最小力量	AWG#24 wire AWG#24 导线	Morethan 30N ≥30N
			AWG#26 wire AWG#26 导线	Morethan 20N ≥20N
			AWG#28 wire AWG#28 导线	Morethan 13N ≥13N
			AWG#30 wire AWG#30 导线	Morethan 8N ≥8N
6.2	Terminal/ Housing Retention Force 端子保持力	Apply axial pull out force at the speed rate of25.4±3mm/minute on the terminal assembled in the Housing 以每分25.4±3mm 的速率, 将端子从Housing 内轴 向拔出力		Per contact: 15N Min 单一接触点: 15N Min
6.3	Insertion & withdraw Force 插拔力	Insert and withdraw Connectors at the speed rate of 25.4±3mm/minute 以每分 25.4±3mm 的速率插入和拔出		Refer to paragraph 8 参照第 8 项
6.4	Pin Retention Force Pin 针保持力	Apply axial push force at the speed rate of 25.4±3mm/minute 以每分 25.4±3mm 的速率, 将 PIN 针从 Wafer 内轴向拔出力		Per contact: 10N Min 单一接触点: 10N Min

7、Endurance Characteristics:

环境性能

NO. 序号	Ltem 项目	Test mode 试验方法	Requirement 技术要求	
7.1	Repeated Insertion/ Withdrawal 重复插拔	When mated up to 30 cycles repeatedly by the rate of 10 cycles per minute 以每分钟不超过 10 次的速率, 将公母插 拔 30 次	Contact Resistance 接触电阻	30 mΩ Max
7.2	Temperature Rise 温升测试	Mating connectors shall be energized at rating current until thermal stability is achieved, and then measured the temperature rise 公母连接器配合后, 加载额定电流直到温 度上升到稳定 状态, 然后再测量温升	Temperature Rise 温升测试	30°C Max
7.3	Vibration test 振动测试	Amplitude: 1.5mm P-P Sweep time: 10~55~10 HZ in 1 minute Duration: 2 hours in each X.Y.Z axials 振幅: 1.5mm P-P 时间: 10~55~10 HZ in 1 minute 持续时间: 每轴向 2 小时	Appearance 外观	No damage 无异常
			Contact Resistance 接触电阻	30 mΩ Max
			Discontinuity 瞬断	1 micro- second Max.
7.4	Heat Resistance 耐热性	85±2°C,96 hours	Appearance 外观	No damage 无异常
			Contact Resistance 接触电阻	30 mΩ Max
7.5	Cold Resistance 耐寒性	-25±3°C,96 hours	Appearance 外观	No damage 无异常
			Contact Resistance 接触电阻	30 mΩ Max
7.6	Humidity 耐湿性	Temperature: 60±2°C Relative Humidity: 90~95% Duration: 96 hours 温度: 60±2°C 湿度: 90~95%(RH) 持续时间: 96 hours	Appearance 外观	No damage 无异常
			Contact Resistance 接触电阻	30 mΩ Max
			Withstand Voltage 耐电压	No Breakdown and Flashover 外观无损伤, 无打火花
			Insulation Resistance 绝缘电阻	1000MΩ Min

NO. 序号	Litem 项目	Test mode 试验方法	Requirement 技术要求	
7.7	温度变化 Temperature Cycling	5 cycles of: a) -25°C 30 minutes b) +85°C 30 minutes	Appearance 外观	No damage 无异常
		从-25°C持续30 分钟升至+85°C持续30 分钟, 循环5 次	Contact Resistance 接触电阻	30 mΩ Max
7.8	Salt spray 盐雾	24±1 hours exposure to a salt spray from the 5±1% solution at 35±2°C	Appearance 外观	No damage 无异常
		在温度35±2°C, 盐水浓度5±1%下, 盐水 喷雾24±1 小时	Contact Resistance 接触电阻	30 mΩ Max
7.9	Solderability 焊锡附着性	Soldering Time: 3-5sec solder Temperature: 245±5°C 焊接时间: 3-5 秒 焊接温度: 245±5°C	Solder Wetting 焊料润湿	Immersion area above 95% 浸渍面积 95% 以上
7.10	Solder- Resistance 焊锡耐热性	DIP type PA66 material welding heat resistance range: Soldering time:3~5sec solder. Temperature:230±5°C DIP 型 PA66 材质焊接耐热范围: 焊接时间: 3~5 秒. 焊接温度: 230±5°C DIP type PA46 material welding heat resistance range: Soldering time:3~5sec solder. Temperature:245±5°C DIP 型 PA46 材质焊接耐热范围: 焊接时间: 3~5 秒. 焊接温度: 245±5°C	Appearance 外观	No damage 无异常

8、INSERTION/WITHDRAWAL FORCE

综合插入力及拔出力

No. of CTK PIN 数	At Initial 初始值		At 30th 插拔 30 次	No. of CTK PIN 数	At Initial 初始值		At 30th 插拔 30 次
	I. F (N Max) 插入力	W. F (N Min) 拔出力	W. F (N Min) 拔出力		W. F (N Min) 拔出力	W. F (N Min) 拔出力	W. F (N Min) 拔出力
2*2	35	10	8	2*12	115	26	24
2*3	45	12	10	2*13	120	27	25
2*4	55	14	12	2*14	125	28	26
2*5	65	16	14	2*15	130	29	27
2*6	75	18	16	2*16	135	30	28
2*7	85	20	18	2*17	140	31	29
2*8	95	22	20	2*18	145	32	30
2*9	100	23	21	2*19	150	33	31
2*10	105	24	22	2*20	155	34	32
2*11	110	25	23				

版本 REV.	日期 DATE	ECN NO.	变更内容 DESCRIPTION	制图 DRAWN

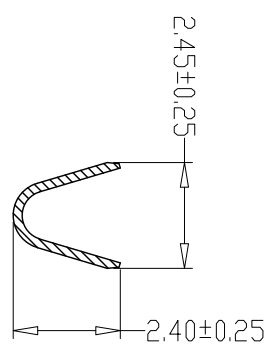
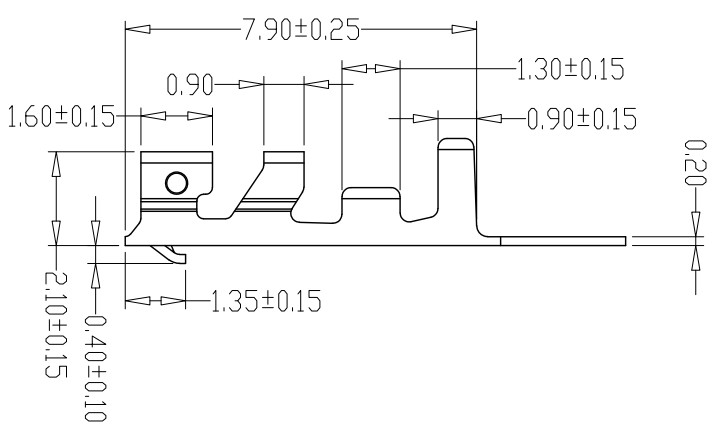
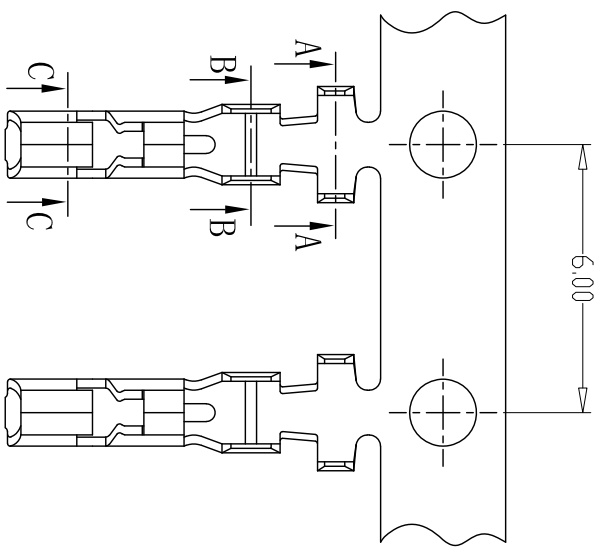

SEC:A-A

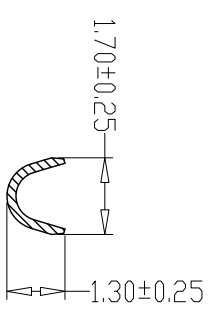

SEC:B-B

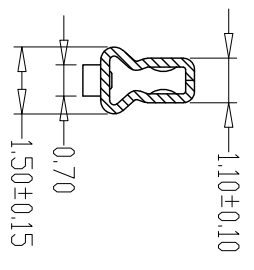

SEC:C-C

SPECIFICATIONS

- 1、Current Rating: 3A AC, DC
- 2、Voltage Rating: 250V AC, DC
- 3、Temperature Range: -25°C~+85°C
- 4、Contact Resistance: 20mΩ Max
- 5、Insulation Resistance: 1000MΩ Min
- 6、Withstanding Voltage: 800V AC/minute
- 7、Material: C5191 Bright tin Ni:0.5-1.0 μm
Sn:2.5-5.0 μm
- 8、Applicable Wire Sizes: AWG#24~30#

GENERAL TOLERANCE		制图 Mapping	张迎春	料号 PART NO.	A20018-1	版本 REV.	A
X \pm 0.25	X \pm 2°	审核 Audit	钱岳生	品名 TITLE	SPI端子	页次 SHEET	1/1
X \pm 0.25	X \pm 1°	核准 Approved	张名	客户料号 CSTM. NO.			
.XX \pm 0.15	.XX \pm 0.5°	单位 Units	2022. 09. 11	比例 SCALE	1:1		
.XXX \pm 0.10	.XXX \pm 0.5°						

乐清市宏一电子有限公司
YueQing HongYi Electronics Co., Ltd

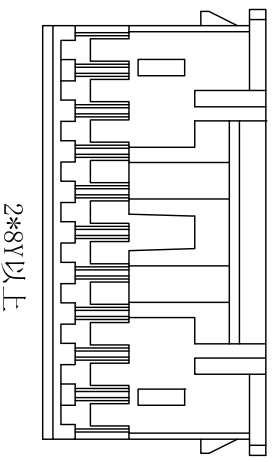
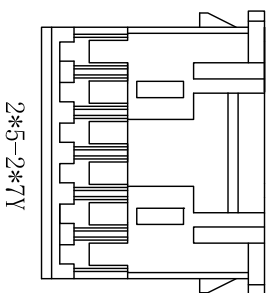
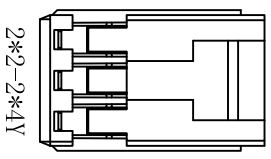
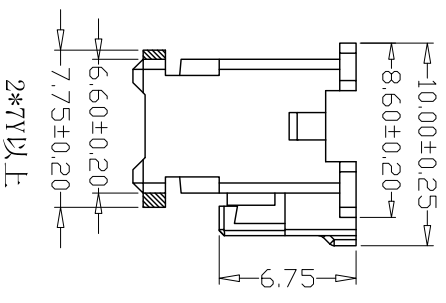
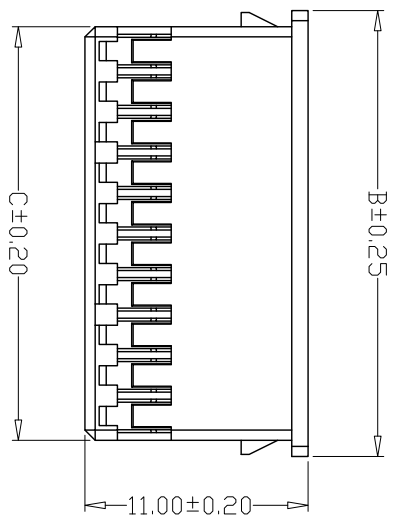
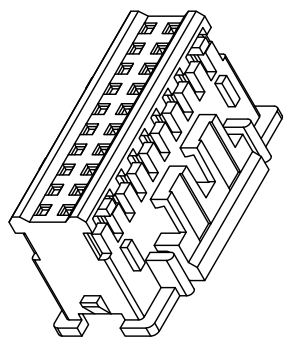
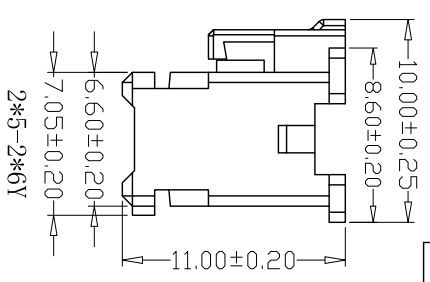
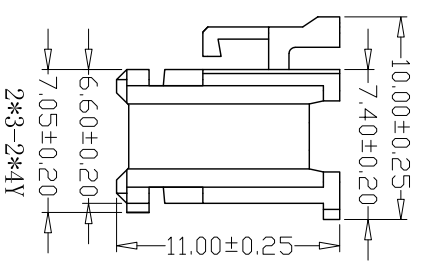
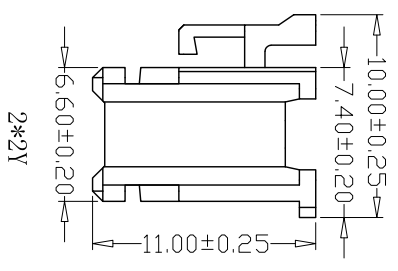
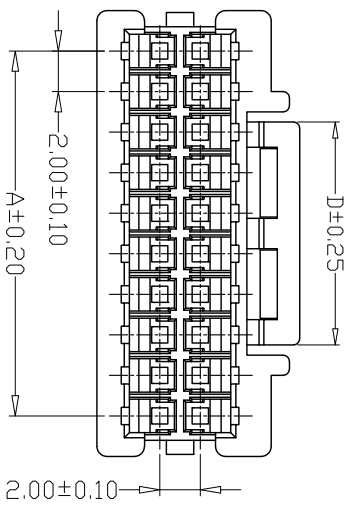

PIN	尺寸 (mm)			
	A	B	C	D
-2*02Y	2.00	4.90	4.90	3.90
-2*03Y	4.00	6.90	6.90	3.90
-2*04Y	6.00	8.90	8.90	3.90
-2*05Y	8.00	12.00	10.40	5.90
-2*06Y	10.00	14.00	12.40	5.90
-2*07Y	12.00	16.00	14.40	5.90
-2*08Y	14.00	18.00	16.40	10.90
-2*09Y	16.00	20.00	18.40	10.90
-2*10Y	18.00	22.00	20.40	10.90
-2*11Y	20.00	24.00	22.40	10.90
-2*12Y	22.00	26.00	24.40	10.90
-2*13Y	24.00	28.00	26.40	10.90
-2*14Y	26.00	30.00	28.40	10.90
-2*15Y	28.00	32.00	30.40	10.90
-2*16Y	30.00	34.00	32.40	10.90
-2*17Y	32.00	36.00	34.40	10.90
-2*18Y	34.00	38.00	36.40	10.90
-2*19Y	36.00	40.00	38.40	10.90
-2*20Y	38.00	42.00	40.40	10.90

SPECIFICATIONS

- 1、Current Rating: 3A AC, DC
- 2、Voltage Rating: 250V AC, DC
- 3、Temperature Range: -25°C~+85°C
- 4、Contact Resistance: 20mΩ Max
- 5、Insulation Resistance: 1000MΩ Min
- 6、Withstanding Voltage: 800V AC/minute
- 7、Material: PA66, UL94V-0 White

GENERAL TOLERANCE		制图 Mapping		张迎春	
X _{±0.25}	X _{±2°}	审核	2022.09.10	钱岳生	2022.09.10
X _{±0.25}	X _{±1°}	批准	2022.09.10	张名	2022.09.11
.XX _{±0.15}	.XX _{±0.5°}	单位	MM	比例	SCALE
.XXX _{±0.10}	.XXX _{±0.5°}	Units	MM	比例	SCALE

料号: A20018-2**n*Y
 品名: SPH孔座
 客户料号: CSTM. NO.
 版本: REV. A
 页次: 1/1
 SHEET

乐清市宏一电子有限公司
 YueDing HongYi Electronics Co., Ltd

版本 REV.	日期 DATE	变更内容 DESCRIPTION	制图 DRAWN

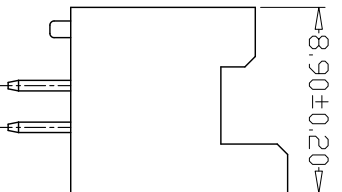
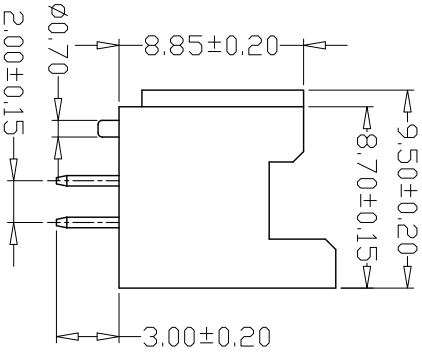
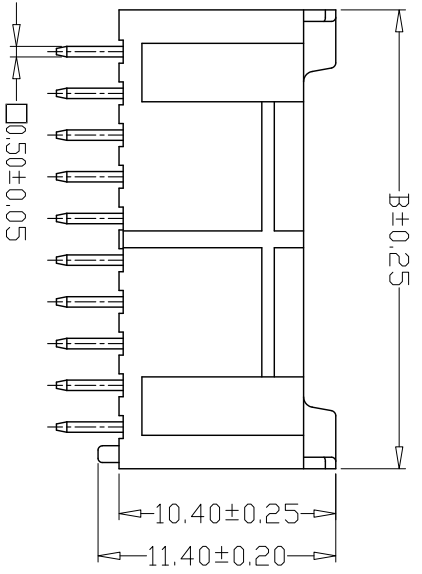
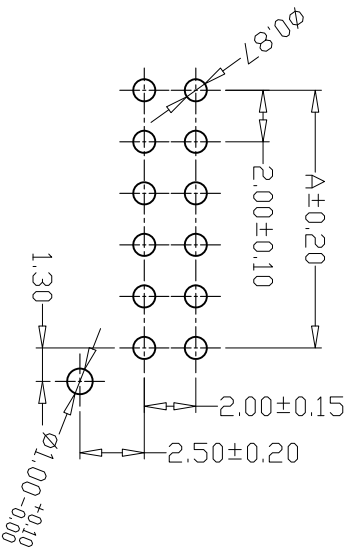
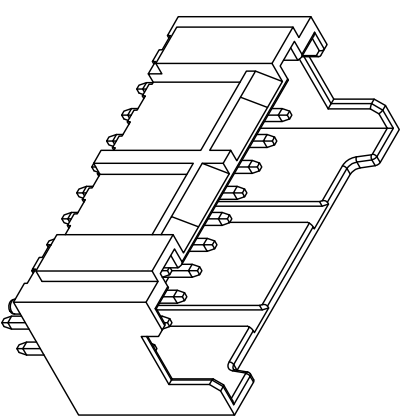
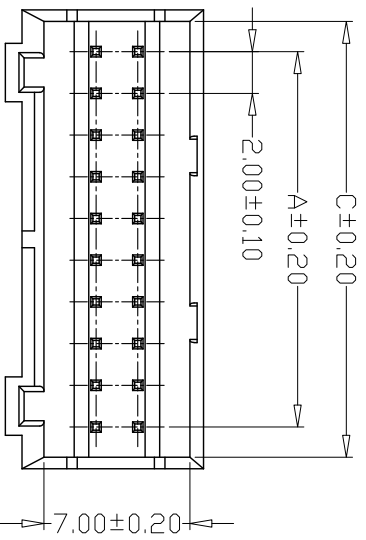

2-3A

PIN	尺寸 (mm)		
	A	B	C
-2*02A	2.00	6.00	4.90
-2*03A	4.00	8.00	6.90
-2*04A	6.00	10.00	8.90
-2*05A	8.00	12.00	10.90
-2*06A	10.00	14.00	12.90
-2*07A	12.00	16.00	14.90
-2*08A	14.00	18.00	16.90
-2*09A	16.00	20.00	18.90
-2*10A	18.00	22.00	20.90
-2*11A	20.00	24.00	22.90
-2*12A	22.00	26.00	24.90
-2*13A	24.00	28.00	26.90
-2*14A	26.00	30.00	28.90
-2*15A	28.00	32.00	30.90
-2*16A	30.00	34.00	32.90
-2*17A	32.00	36.00	34.90
-2*18A	34.00	38.00	36.90
-2*19A	36.00	40.00	38.90
-2*20A	38.00	42.00	40.90

SPECIFICATIONS

- 1、Current Rating: 3A AC, DC
- 2、Voltage Rating: 250V AC, DC
- 3、Temperature Range: -25°C~+85°C
- 4、Contact Resistance: 20mΩ Max
- 5、Insulation Resistance: 1000MΩ Min
- 6、Withstanding Voltage: 800V AC/minute
- 7、Material: Wafer PA66, UL94V-0 White
PIN Brass Tin-plated

GENERAL TOLERANCE		制图 Mapping		张迎春	
X _{±0.25}	X° _{±2°}	审核	2022.09.10	钱岳生	2022.09.10
X _{±0.25}	X° _{±1°}	核准	2022.09.10	张名	2022.09.11
X _{±0.15}	X _{°±0.5°}	Approved	2022.09.11	MM	SCALE
XXX _{±0.10}	XXX _{°±0.5°}	单位 Units	1:1	比例	1:1

料号		品名		客户料号	
A20018-2*NA	SPH直针	客户料号	WAFER DIP TYPE	客户料号	WAFER DIP TYPE
版本 REV.	页次 SHEET	客户料号	WAFER DIP TYPE	客户料号	WAFER DIP TYPE
A	1/2	客户料号	WAFER DIP TYPE	客户料号	WAFER DIP TYPE

乐清市宏一电子有限公司
YueDing HongYi Electronics Co., Ltd

版本 REV.	日期 DATE	ECN NO.	变更内容 DESCRIPTION	制图 DRAWN

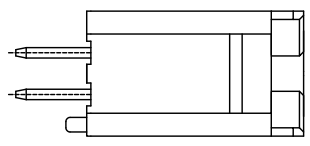

2*2-2*3A

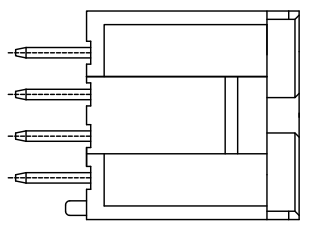

2*4A

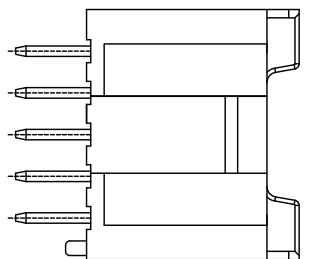

2*5A

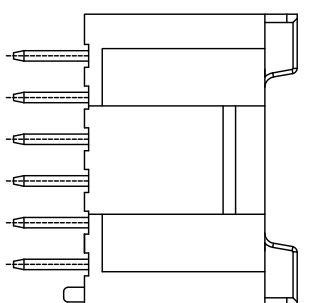

2*6A

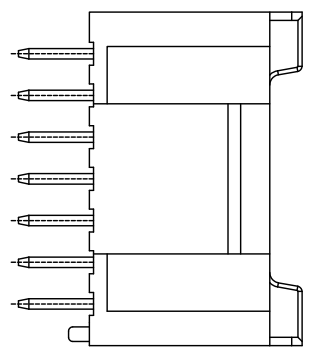

2*7A

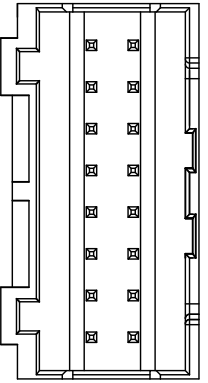
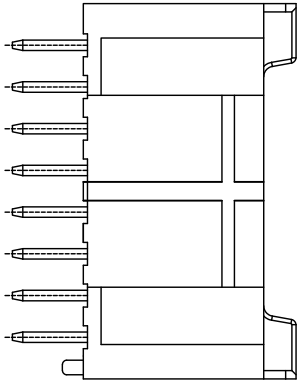
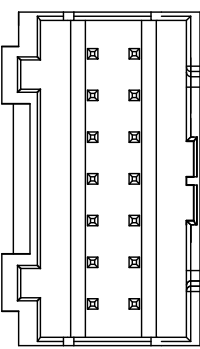
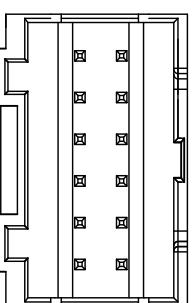
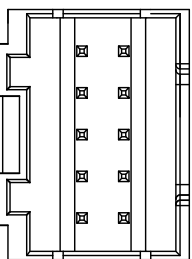
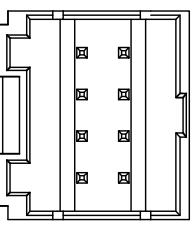
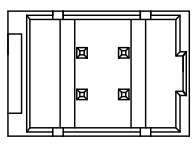

2*8A以上

GENERAL TOLERANCE		制图 Mapping		料号 PART NO.	版本 REV.
X \pm 0.25	X $^{\circ}$ \pm 2 $^{\circ}$	张迎春	2022. 09、 10	A20018-2*nA	A
X \pm 0.25	X $^{\circ}$ \pm 1 $^{\circ}$	审核 Audit	钱岳生	SPH直针	页次 SHEET
.XX \pm 0.15	.XX $^{\circ}$ \pm 0.5 $^{\circ}$	核准 Approved	2022. 09、 10	客户料号 CUSTOMER PART NO.	2/2
.XXX \pm 0.10	.XXX $^{\circ}$ \pm 0.5 $^{\circ}$	单位 Units	张名		
		MM	2022. 09、 11		
		SCALE	比例 SCALE		
			1:1		
				乐清市宏一电子有限公司 Yueqing Hongyi Electronics Co., Ltd	

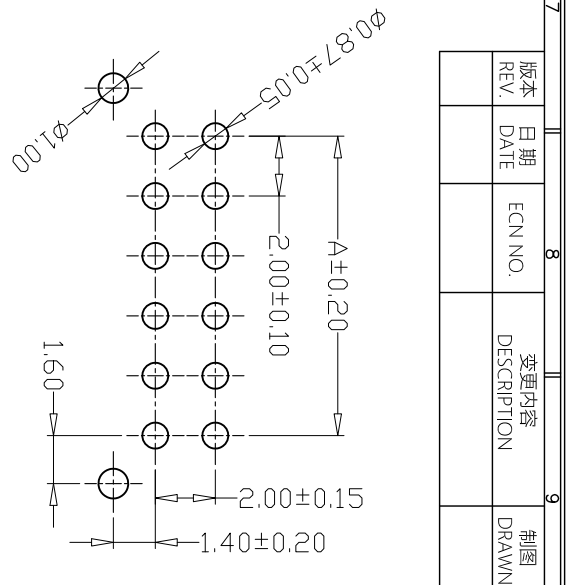
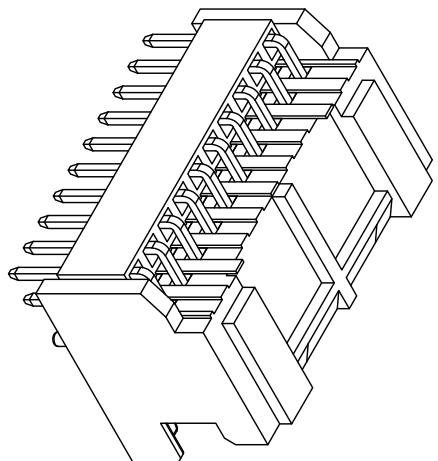
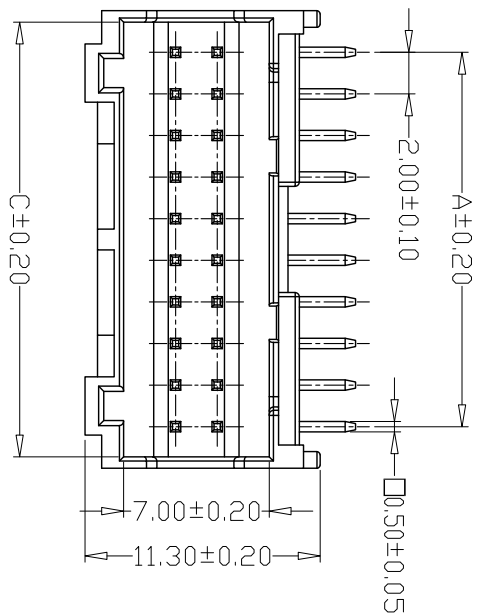

PCB LAYOUT

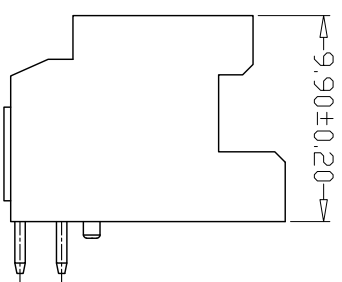
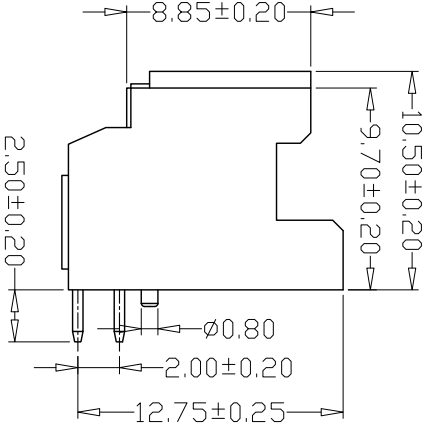
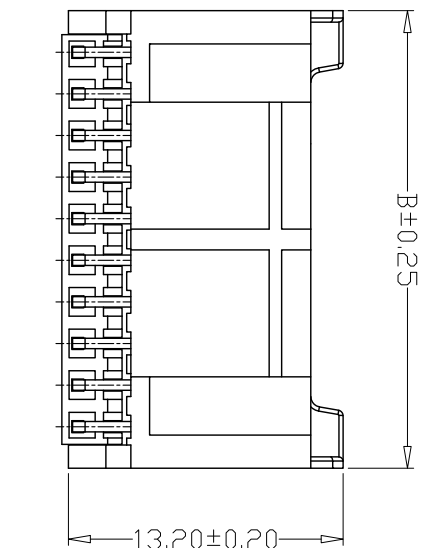

2*2-2*3AW

PIN	尺寸 (mm)		
	A	B	C
-2*02AW	2.00	6.00	4.90
-2*03AW	4.00	8.00	6.90
-2*04AW	6.00	10.00	8.90
-2*05AW	8.00	12.00	10.90
-2*06AW	10.00	14.00	12.90
-2*07AW	12.00	16.00	14.90
-2*08AW	14.00	18.00	16.90
-2*09AW	16.00	20.00	18.90
-2*10AW	18.00	22.00	20.90
-2*11AW	20.00	24.00	22.90
-2*12AW	22.00	26.00	24.90
-2*13AW	24.00	28.00	26.90
-2*14AW	26.00	30.00	28.90
-2*15AW	28.00	32.00	30.90
-2*16AW	30.00	34.00	32.90
-2*17AW	32.00	36.00	34.90
-2*18AW	34.00	38.00	36.90
-2*19AW	36.00	40.00	38.90
-2*20AW	38.00	42.00	40.90

SPECIFICATIONS

- 1、Current Rating: 3A AC, DC
- 2、Voltage Rating: 250V AC, DC
- 3、Temperature Range: -25°C~+85°C
- 4、Contact Resistance: 20mΩ Max
- 5、Insulation Resistance: 1000MΩ Min
- 6、Withstanding Voltage: 800V AC/minute
- 7、Material: Wafer PA66, UL94V-0 White
PIN Brass Tin-plated

GENERAL TOLERANCE		制图 Mapping		张迎春	
X±0.25	X°±2°	审核	钱岳生	2022.09.10	
X±0.25	X°±1°	核准	张名	2022.09.10	
.XX±0.15	.XX°±0.5°	Approved	2022.09.11		
.XXX±0.10	.XXX°±0.5°	单位 Units	MM SCALE	1:1	

料号 PART NO. A20018-2*1AW
 品名 TITLE SPH弯针
 客户料号 WAFER DIP TYPE
 CTRM. NO. SHEET 1/2

乐清市宏一电子有限公司
 YueDing HongYi Electronics Co., Ltd

版本 REV.	日期 DATE	ECN NO.	变更内容 DESCRIPTION	制图 DRAWN

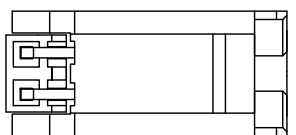

2*2-2*3AW

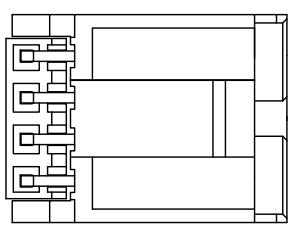

2*4AW

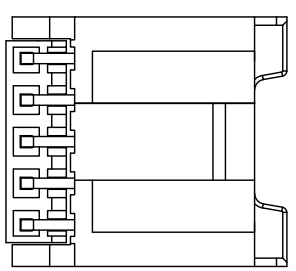

2*5AW

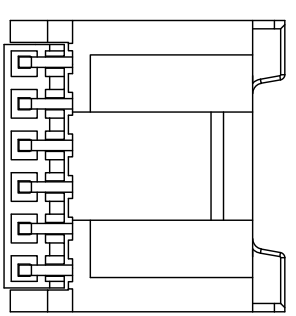

2*6AW

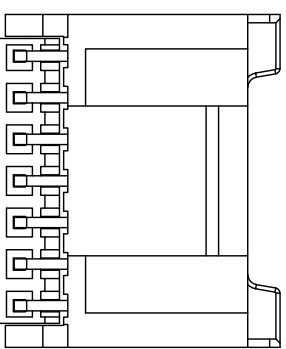

2*7AW

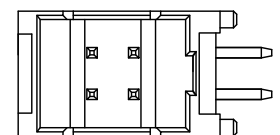

2*8AW以上

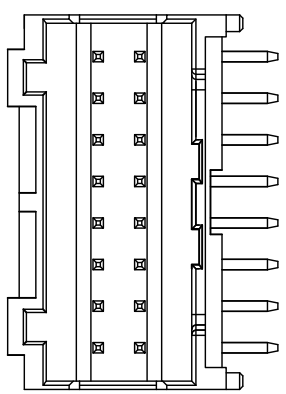
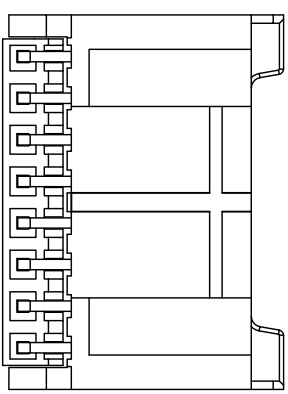

GENERAL TOLERANCE		制图 Mapping	张迎春	料号 PART NO.	A20018-2*nAW	版本 REV.	A
X \pm 0.25	X \pm 2°	审核 Audit	2022、09、10	品名 TITLE	SPH弯针 WAFER DIP TYPE	页次 SHEET	2/2
X \pm 0.25	X \pm 1°	核准 Approved	2022、09、10	客户料号 CSTM. NO.			
.XX \pm 0.15	.XX \pm 0.5°	单位 Units	2022、09、11	张名			
.XXX \pm 0.10	.XXX \pm 0.5°	MM	SCALE	1:1			

乐清市宏一电子有限公司
YueDing HongYi Electronics Co., Ltd